



RSLNBIMKA11T3

LNB Redundant Switch System Multi-Band

Redundancy: 1:1

Band: Ka-Band

Tx/Rx Config + IFL Length: Tx/Rx + 30m IFL

Norsat's Redundant LNB Switch Systems automatically detect signal faults and switch to an alternate LNB, LNA or BDC - providing maximum satellite service availability.

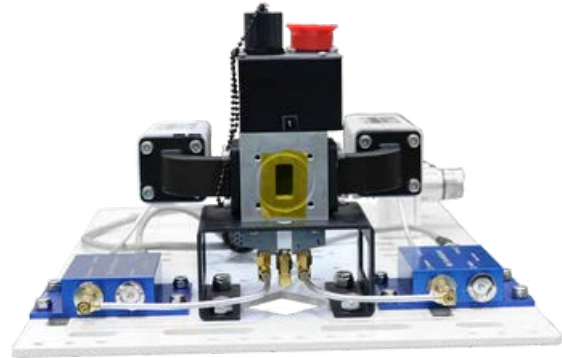

[Explore Video Course](#)



KEY SPECIFICATIONS

Band	Ka-Band
Redundancy	1:1
Switchover Time	120 ms max.

RF SPECIFICATIONS

Input VSWR	LNB Dependent
Insertion Loss	0.5 dB max.

ELECTRICAL SPECIFICATIONS

Power	90 - 264 VAC (47 - 63 Hz)
--------------	---------------------------

INTERFACE SPECIFICATIONS

Component	LNB, Internal Ref, Multi-Band
IFL Cable Length	30m
RF Input Connector	Ka-Band: WR-42



RF Output Connector	N-Connector
Tx Rx Configuration	Tx / Rx

ENVIRONMENTAL SPECIFICATIONS

Relative Humidity	< 100%
Temperature Operational	-40°C to +60°C

PHYSICAL SPECIFICATIONS

Packaging	26 x 23 x 27 in (661 x 584 x 686 mm)
Product Height	295 mm
Product Length	483 mm
Product Weight	9 kg
Product Width	159 mm

LOGISTICS SPECIFICATIONS

HS Code	Country of Origin	Ex Works	ECCN Number	Unit Package
8517690000	Made in Canada	Richmond, BC, Canada	EAR99	660 mm x 610 mm x 736 mm 54.8 kg

HOW TO ORDER

RSLNBISKU11R3

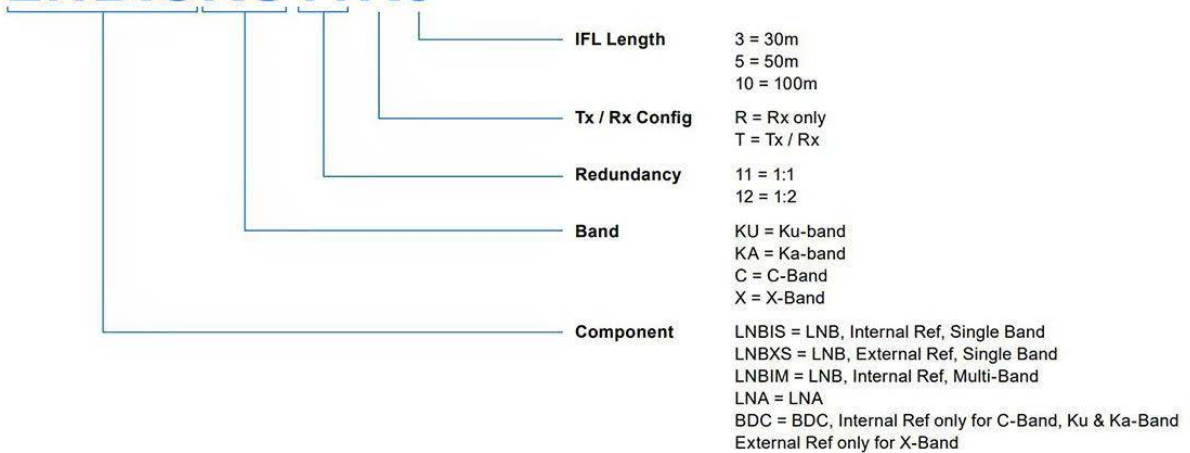

Note: LNBIM not available for C-Band, X-Band

MECHANICAL DIAGRAMS



Norsat
International Inc.

Innovative Communication Solutions

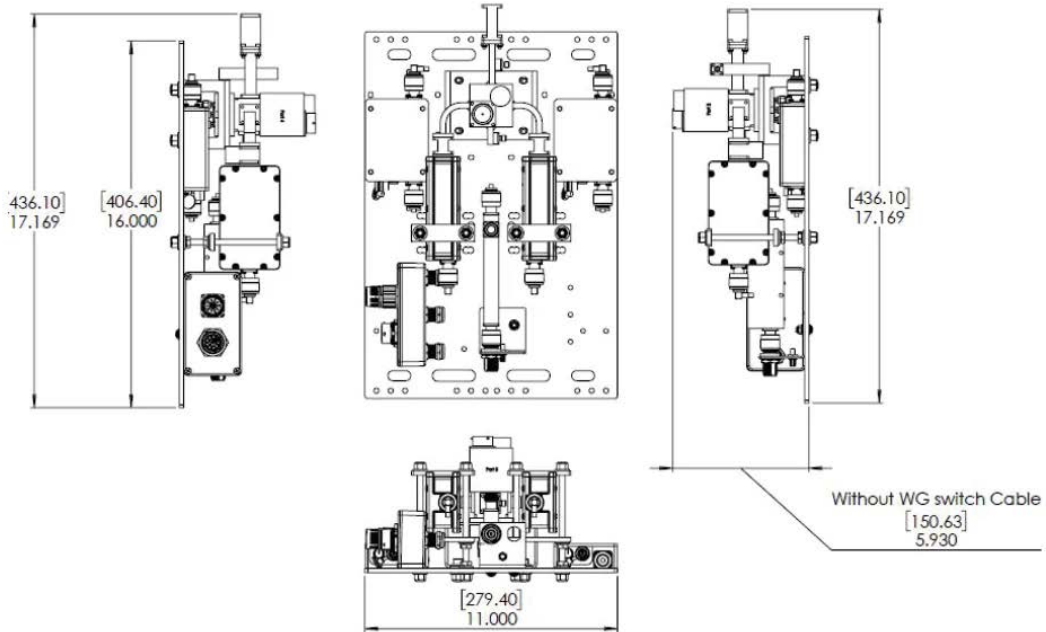

Norsat authorized distributor

Esatcom Inc.
3628 Francis Lewis Blvd.
Flushing, NY 11358
www.esatcom.com
Tel: 718.799.0084
Email: sales@esatcom.com